

Разпределител ROS 5I със защиты



Структура на обозначаването за поръчка

ROS 5II-

Номер на изпълнение на разпределителните устройства

01, 10, 11, 12, 13
14, 15, 16, 41, 50
51, 52, 53, 54, 55
56

Структура на разпределителното табло



Контакт IEN 1643



Контакт IEN 1653



Контакт IEN 3243



Контакт IEN 3253



Контакт VZ 16 или VZ 16S



Трифазен автоматичен прекъсвач 16A/C



Трифазен автоматичен прекъсвач 32A/C



Еднофазен автоматичен прекъсвач 16A/B

Технически данни

Номинално напрежение	400/230 V, (50 Hz)
Номинално изолационно напрежение U_i	500V
Номинално импулсно поносимо напрежение U_{imp}	4 kV
Номинален постоянен ток $I_u = I_n$	32A
Степен на защита	IP44
Клас на сигурност	II
Сечение на свързващите проводници	2,5...6 mm ²
Характеристика на освобождаването на миниатюрните прекъсвачи	тип B (1-фаза) тип C (3-фази)

Размери

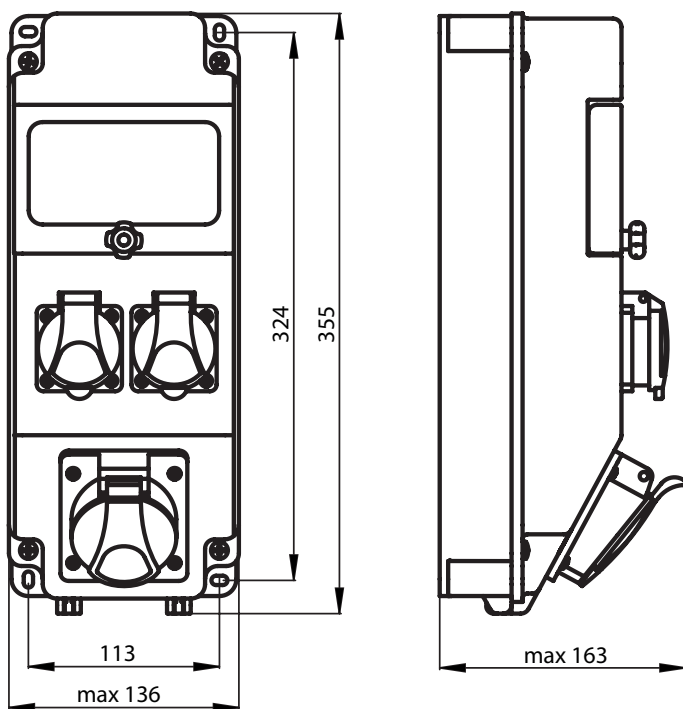

Изпълнения

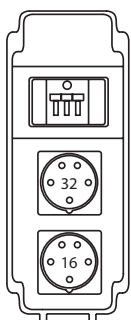

ROS 5\I-01

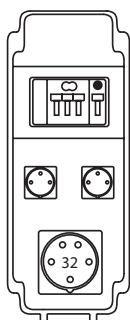

ROS 5\I-10

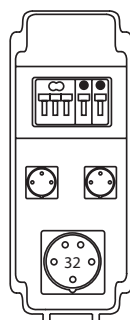

ROS 5\I-11

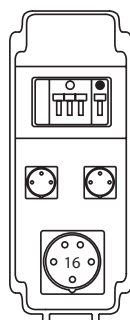

ROS 5\I-12

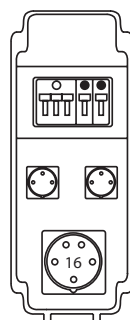

ROS 5\I-13

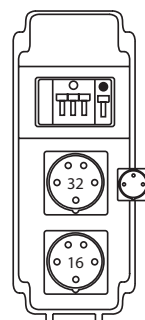

ROS 5\I-14

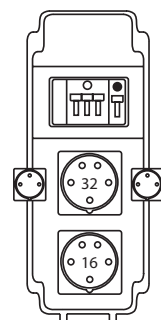

ROS 5\I-15

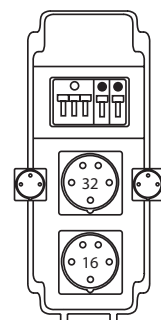

ROS 5\I-16

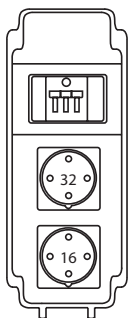

ROS 5\I-41

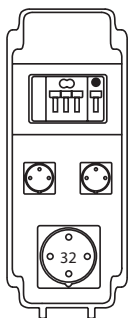

ROS 5\I-50

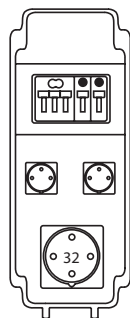

ROS 5\I-51

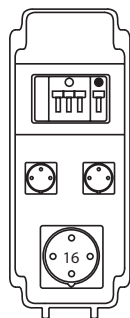

ROS 5\I-52

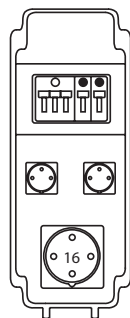

ROS 5\I-53

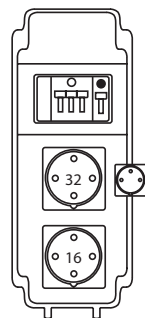

ROS 5\I-54

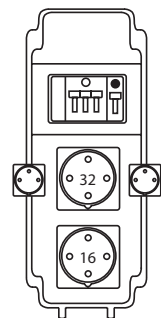

ROS 5\I-55

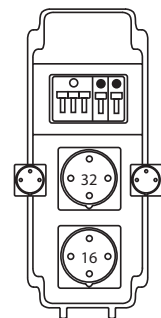

ROS 5\I-56