

Разпределител ROS 7X без защиты



Структура на обозначаването за поръчка

ROS 7X-

Номер на изпълнение на разпределителните устройства

01, 02, 11, 12, 41
42, 51, 52

Структура на разпределителното табло



Контакт IEN 1643



Контакт IEN 1653



Контакт IEN 3243



Контакт IEN 3253



Контакт VZ 16 или VZ 165



Прекъсвач на захранването



Превключвател за реверсиране на оборотите

Технически данни

Номинално напрежение	400/230 V, (50 Hz)
Номинално изолационно напрежение U_i	500V
Номинално импулсно поносимо напрежение U_{imp}	4 kV
Номинален постоянен ток $I_u = I_n$	32A
Степен на защита	IP44
Клас на сигурност	II
Сечение на свързващите проводници	2,5...6 mm ²

Размери

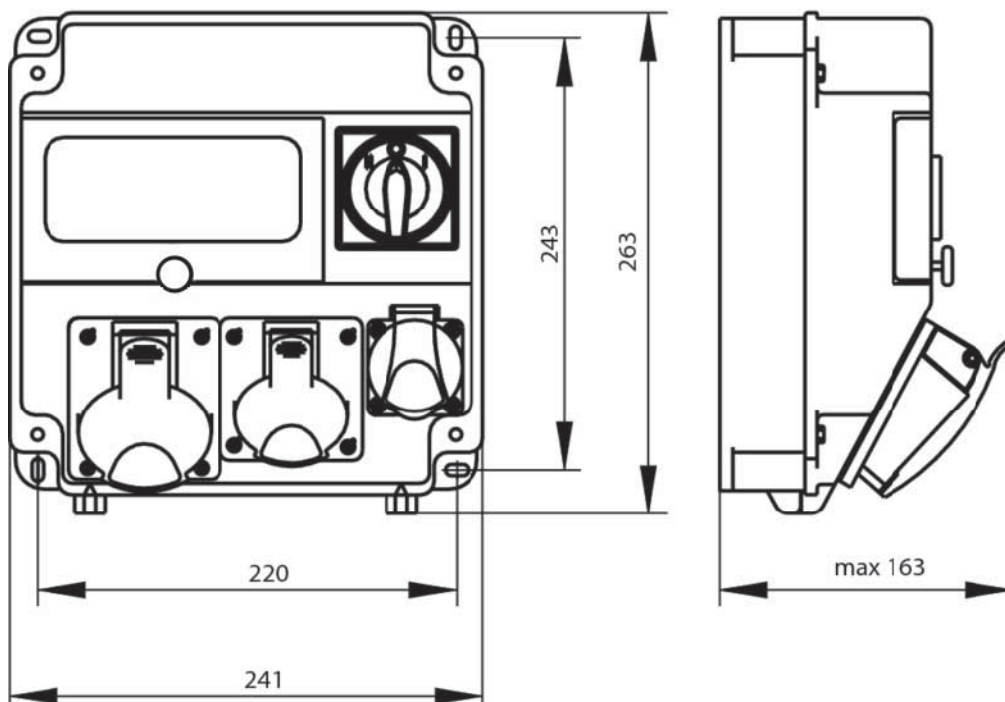

Изпълнения

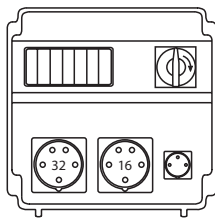

ROS 7\X-01

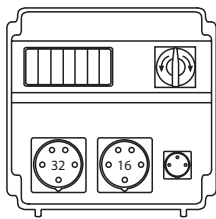

ROS 7\X-02

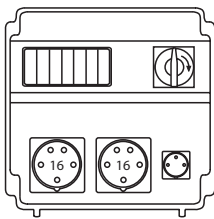

ROS 7\X-11

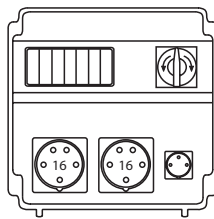

ROS 7\X-12

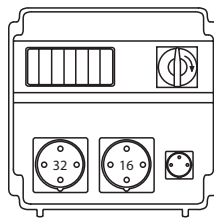

ROS 7\X-41

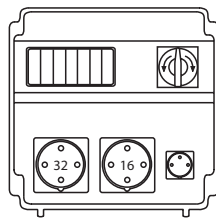

ROS 7\X-42

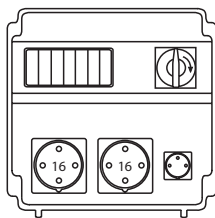

ROS 7\X-51

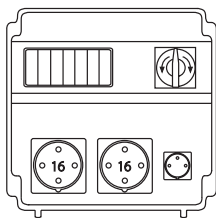

ROS 7\X-52