

## Rozvodná krabice ROS 5/X bez jističů



### Složení objednáčíchó kódu

ROS 5IX-

Č. provedení rozvodnice

01, 10, 12, 14, 15  
41, 50, 52, 54, 55

### Složení rozvodnic



Zásuvka IEN 1643



Zásuvka IEN 1653



Zásuvka IEN 3243



Zásuvka IEN 3253



Zásuvka VZ 16 nebo VZ 16S

### Technické data

Jmenovité napětí	400/230 V, (50 Hz)
Jmenovité izolační napětí $U_i$	500 V
Jmenovité impulzní napětí $U_{imp}$	4 kV
Jmenovitý tepelný proud $I_n = I_u$	32 A
Stupeň ochrany	IP44
Stupeň ochrany	II
Průřez připojovacích vodičů	2,5...6 mm <sup>2</sup>

### Rozměry

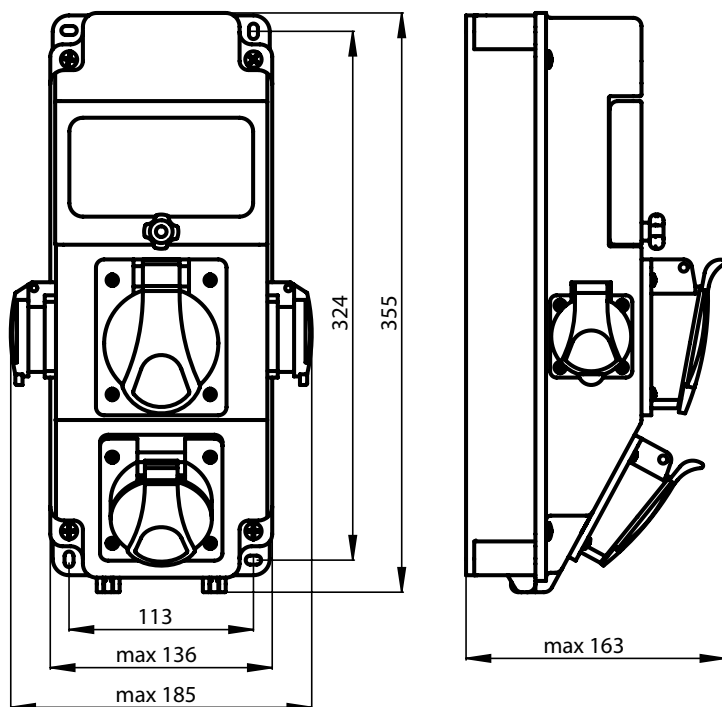

## Provedení

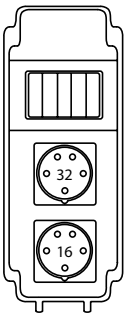

ROS 5\X-01

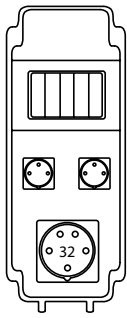

ROS 5\X-10

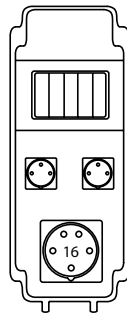

ROS 5\X-12

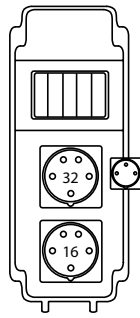

ROS 5\X-14

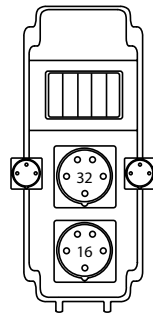

ROS 5\X-15

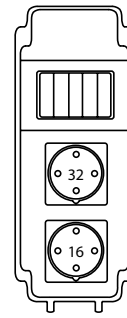

ROS 5\X-41

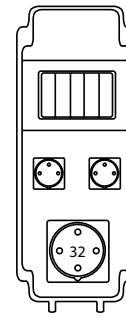

ROS 5\X-50

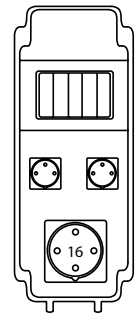

ROS 5\X-52

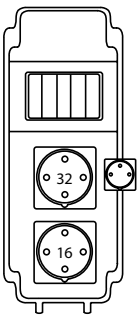

ROS 5\X-54

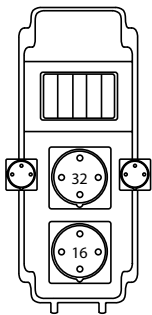

ROS 5\X-55