

## Rozvaděč SLIM



### Složení objednáčíchó kódu

ROS-SLIM \

Č. provedení rozvodnice

1600, 1601, 1602, 1603, 1604  
1605, 3200, 3201, 1602S, 1603S  
1604S, 1605S

### Složení rozvodnic



Zásuvka IEN 1643



Zásuvka IEN 1653



Zásuvka IEN 3243



Zásuvka IEN 3253



Zásuvka VZ 16 nebo VZ 16S

### Popis výrobku

Rozdzielnice ROS typu SLIM charakteryzują się prosą i ergonomiczną budową. Przeznaczone są do podłączenia urządzeń jedno- i trójfazowych. Rozdzielnice są zgodne z wymaganiami norm: EN 60309-1 i EN 60309-2. Przystosowane są do podłączenia kabla zasilającego o maksymalnym przekroju 5x4 mm<sup>2</sup>.

### Technické data

Jmenovité napětí	250/400 V, (50 Hz)
Jmenovitý tepelný proud $I_n = I_u$	16/32 A
Stupeň ochrany	IP44
Průřez připojovacích vodičů	maks. 4 mm <sup>2</sup>
Stupeň ochrany proti nárazu	IK10

### Rozměry

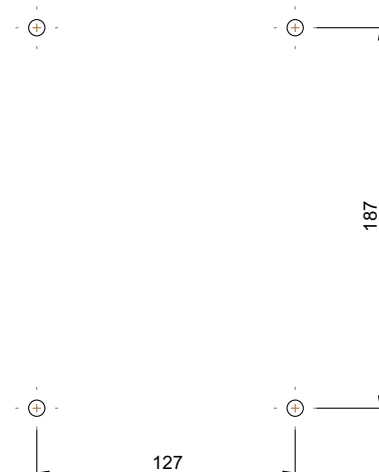
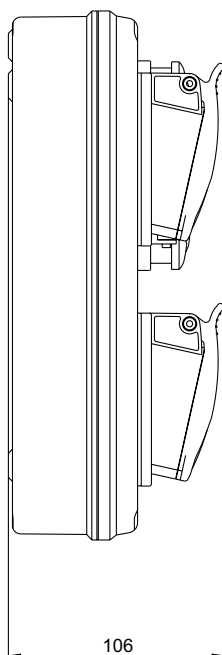
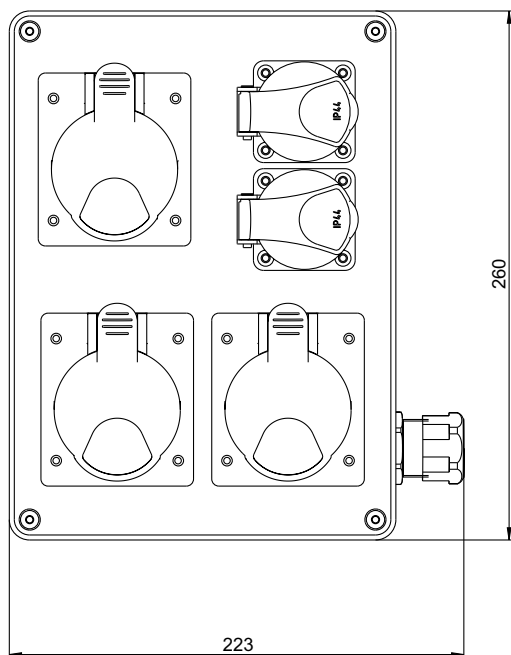

## Provedení

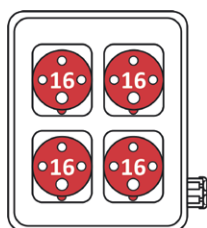

ROS-SLIM 1600  
1600

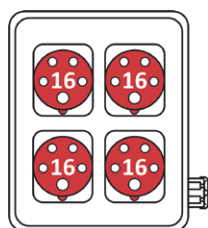

ROS-SLIM 1601  
1601

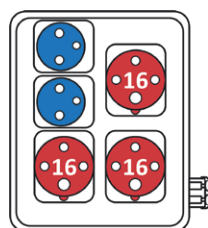

ROS-SLIM 1602  
1602

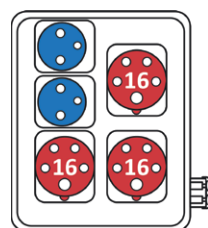

ROS-SLIM 1603  
1603

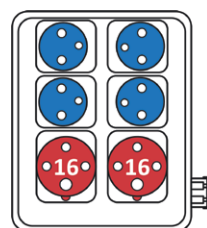

ROS-SLIM 1604  
1604

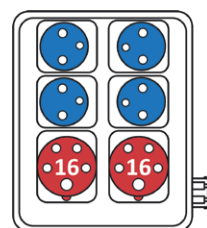

ROS-SLIM 1605  
1605

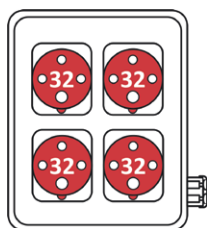

ROS-SLIM 3200  
3200

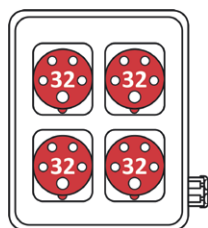

ROS-SLIM 3201  
3201

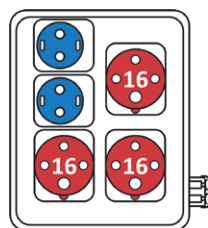

ROS-SLIM 1602S  
1602S

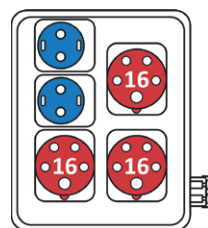

ROS-SLIM 1603S  
1603S

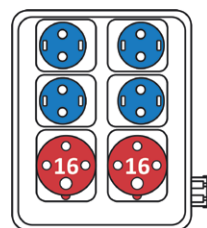

ROS-SLIM 1604S  
1604S

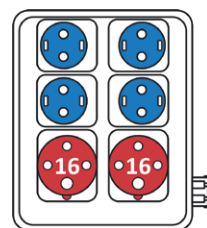

ROS-SLIM 1605S  
1605S