

## Rozváděč SLIM s bezpečnostním oknem



### Složení objednáčíchó kódu

ROS-SLIMX

Č. provedení rozvodnice

1600A, 1601A, 1602A, 1603A, 3200A  
3201A, 1600AS, 1601AS, 1602AS, 1603AS  
3200AS, 3201AS

### Složení rozvodnic



Zásuvka IEN 1643



Zásuvka IEN 1653



Zásuvka IEN 3243



Zásuvka IEN 3253



Zásuvka VZ 16 nebo VZ 16S

### Popis výrobku

Rozdzielnice ROS typu SLIM charakteryzują się prosą i ergonomiczną budową. Przeznaczone są do podłączenia urządzeń jedno- i trójfazowych. Rozdzielnice są zgodne z wymaganiami norm: EN 60309-1 i EN 60309-2. Przystosowane są do podłączenia kabla zasilającego o maksymalnym przekroju 5x4 mm<sup>2</sup>.

### Technické data

Jmenovité napětí	250/400 V, (50 Hz)
Jmenovitý tepelný proud $I_n = I_u$	16/32 A
Stupeň ochrany	IP44
Průřez připojovacích vodičů	maks. 4 mm <sup>2</sup>
Stupeň ochrany proti nárazu	IK10

### Rozměry

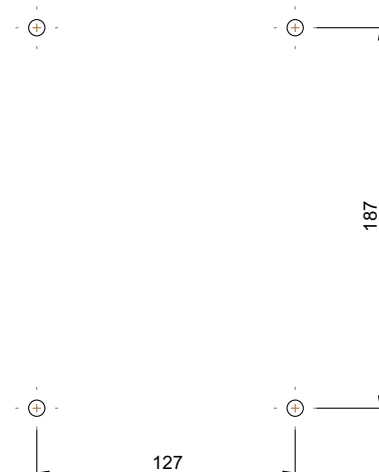
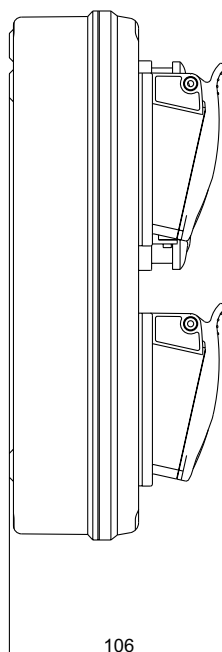
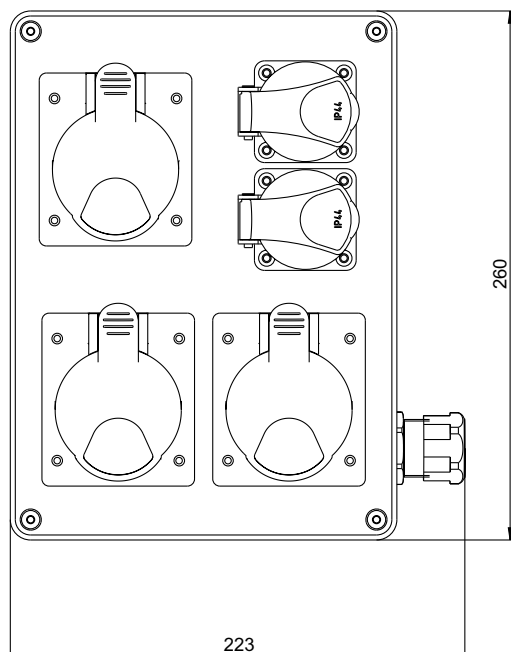

## Provedení

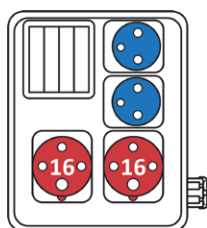

ROS-SLIM X1600A  
1600A

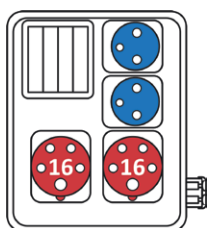

ROS-SLIM X1601A  
1601A

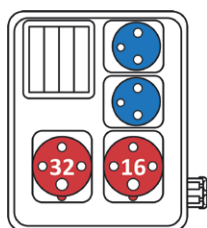

ROS-SLIM X1602A  
1602A

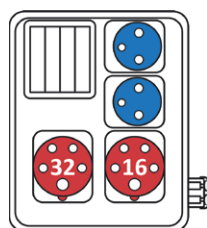

ROS-SLIM X1603A  
1603A

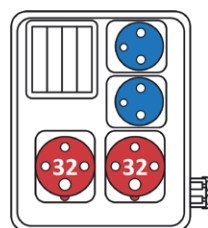

ROS-SLIM X3200A  
3200A

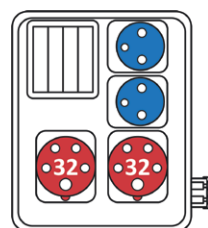

ROS-SLIM X3201A  
3201A

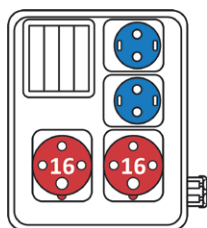

ROS-SLIM X1600AS  
1600AS

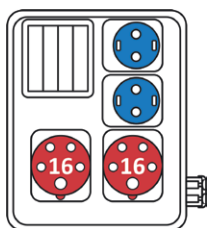

ROS-SLIM X1601AS  
1601AS

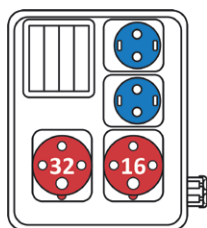

ROS-SLIM X1602AS  
1602AS

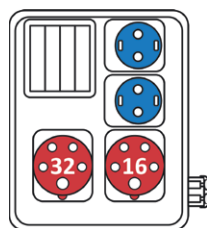

ROS-SLIM X1603AS  
1603AS

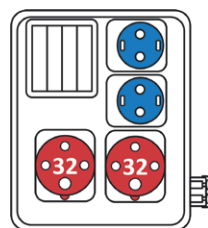

ROS-SLIM X3200AS  
3200AS

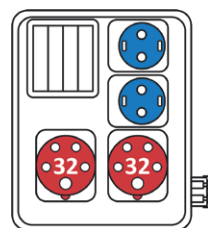

ROS-SLIM X3201AS  
3201AS