

Rozváděč SLIM s bezpečnostním oknem a rukojetí



## Složení objednáčíchó kódu

ROS-SLIMX

Č. provedení rozvodnice

1600DA, 1601DA, 1602DA, 1603DA, 3200DA  
3201DA, 1600DAS, 1601DAS, 1602DAS, 1603DAS  
3200DAS, 3201DAS

## Složení rozvodnic



Zásuvka IEN 1643



Zásuvka IEN 1653



Zásuvka IEN 3243



Zásuvka IEN 3253



Zásuvka VZ 16 nebo VZ 16S

## Popis výrobku

Rozdzielnice ROS typu SLIM charakteryzują się prosą i ergonomiczną budową. Przeznaczone są do podłączenia urządzeń jedno- i trójfazowych. Rozdzielnice są zgodne z wymaganiami norm: EN 60309-1 i EN 60309-2. Przystosowane są do podłączenia kabla zasilającego o maksymalnym przekroju 5x4 mm<sup>2</sup>.

## Technické data

Jmenovité napětí	250/400 V, (50 Hz)
Jmenovitý tepelný proud $I_n = I_u$	16/32 A
Stupeň ochrany	IP44
Průřez připojovacích vodičů	maks. 4 mm <sup>2</sup>
Stupeň ochrany proti nárazu	IK10

## Rozměry

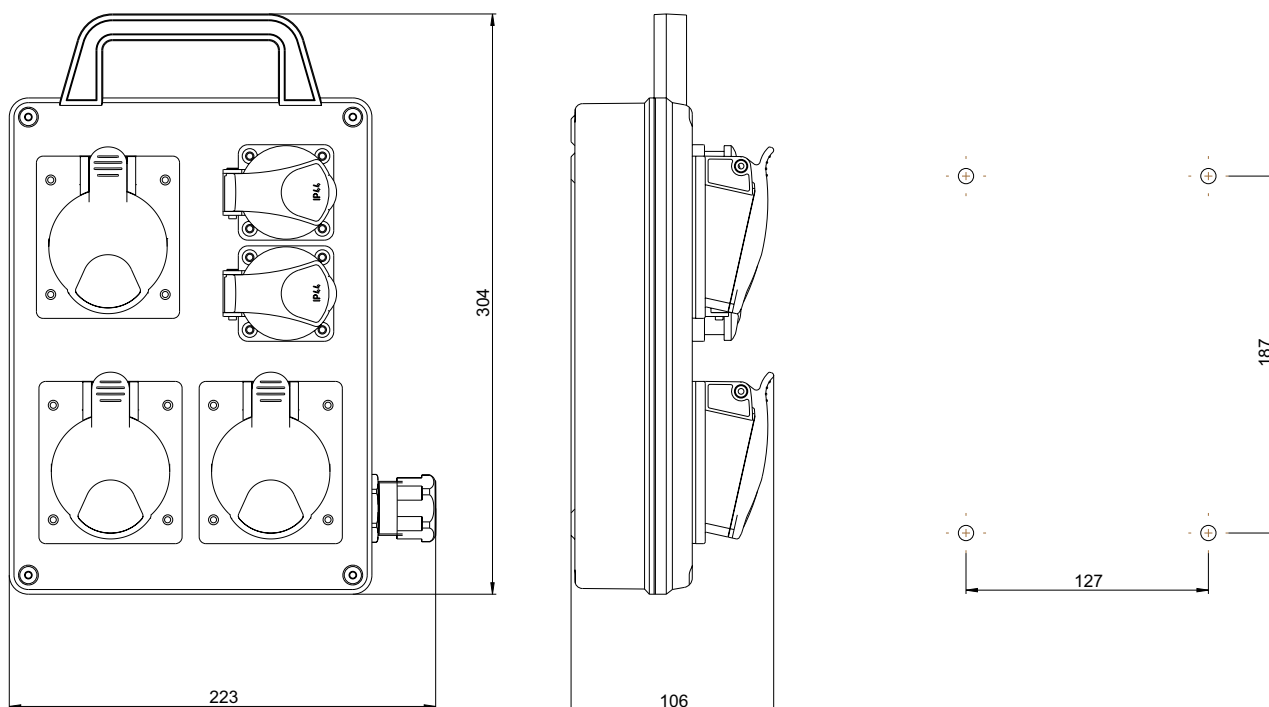

## Provedení

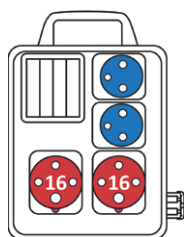

ROS-SLIM X1600DA

1600DA

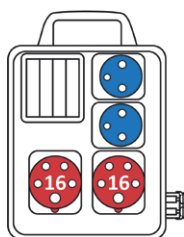

ROS-SLIM X1601DA

1601DA

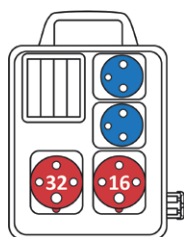

ROS-SLIM X1602DA

1602DA

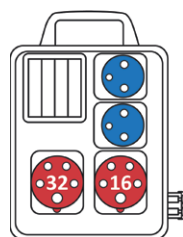

ROS-SLIM X1603DA

1603DA

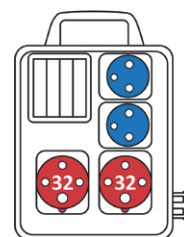

ROS-SLIM X3200DA

3200DA

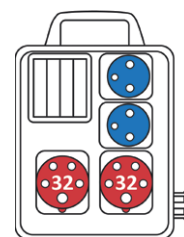

ROS-SLIM X3201DA

3201DA

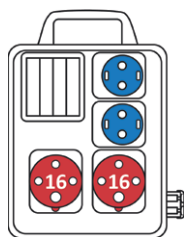

ROS-SLIM X1600DAS

1600DAS

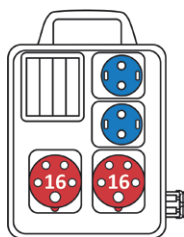

ROS-SLIM X1601DAS

1601DAS

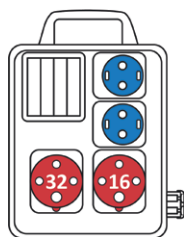

ROS-SLIM X1602DAS

1602DAS

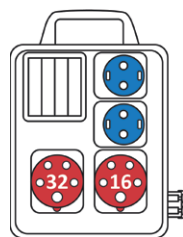

ROS-SLIM X1603DAS

1603DAS

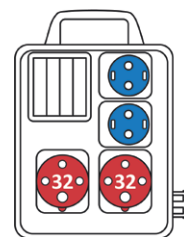

ROS-SLIM X3200DAS

3200DAS

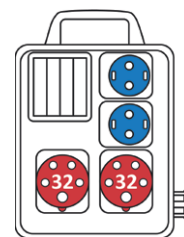

ROS-SLIM X3201DAS

3201DAS