

Rozvaděč SLIM s rukojetí



Složení objednáčíchó kódu

ROS-SLIM

Č. provedení rozvodnice

1600D, 1601D, 1602D, 1603D, 1604D
1605D, 3200D, 3201D, 1602DS, 1603DS
1604DS, 1605DS

Složení rozvodnic



Zásuvka IEN 1643



Zásuvka IEN 1653



Zásuvka IEN 3243



Zásuvka IEN 3253



Zásuvka VZ 16 nebo VZ 16S

Popis výrobku

Rozdzielnice ROS typu SLIM charakteryzują się prosą i ergonomiczną budową. Przeznaczone są do podłączania urządzeń jedno- i trójfazowych. Rozdzielnice są zgodne z wymaganiami norm: EN 60309-1 i EN 60309-2. Przystosowane są do podłączenia kabla zasilającego o maksymalnym przekroju 5x4 mm².

Technické data

Jmenovité napětí	250/400 V, (50 Hz)
Jmenovitý tepelný proud $I_n = I_u$	16/32 A
Stupeň ochrany	IP44
Průřez připojovacích vodičů	maks. 4 mm ²
Stupeň ochrany proti nárazu	IK10

Rozměry

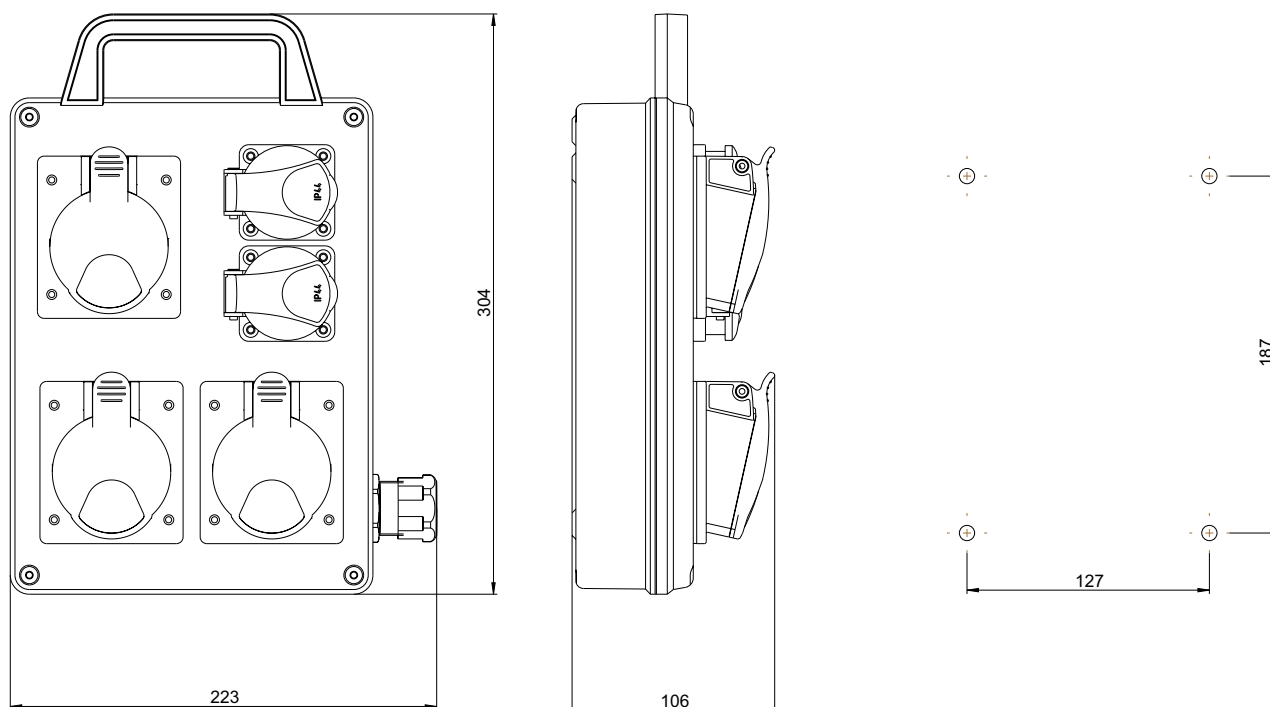

Provedení

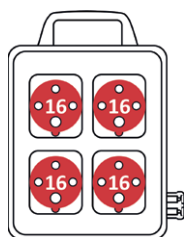

ROS-SLIM 1600D

1600D

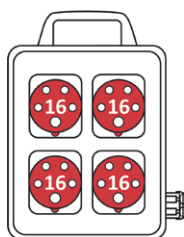

ROS-SLIM 1601D

1601D

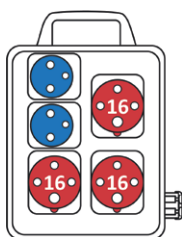

ROS-SLIM 1602D

1602D

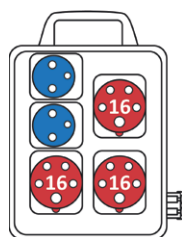

ROS-SLIM 1603D

1603D

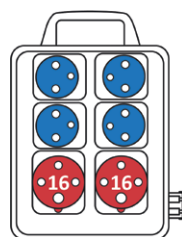

ROS-SLIM 1604D

1604D

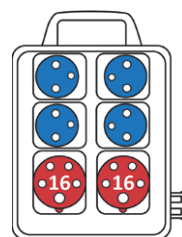

ROS-SLIM 1605D

1605D

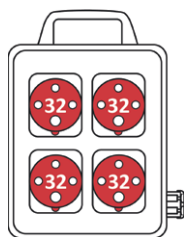

ROS-SLIM 3200D

3200D

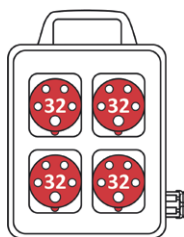

ROS-SLIM 3201D

3201D

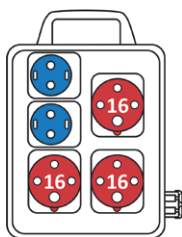

ROS-SLIM 1602DS

1602DS

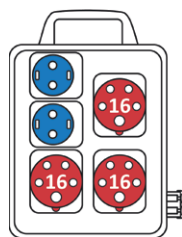

ROS-SLIM 1603DS

1603DS

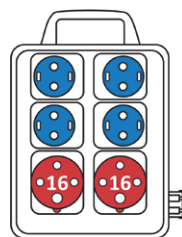

ROS-SLIM 1604DS

1604DS

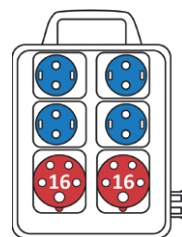

ROS-SLIM 1605DS

1605DS