

Steckdosenverteiler ROS 11I mit Absicherungen



Aufbau der Bestellnummer

ROS 11I-

Ausführungsnummer des Steckdosenverteilers

01, 02, 03, 04, 05
06, 07, 08, 11, 12
13, 14, 15, 16, 17
21, 22, 23, 25, 26
41, 42, 43, 44, 45
46, 47, 48, 51, 52
53, 54, 55, 56, 57
61, 62, 63

Aufbau des Steckdosenverteilers



Büchse IEN 1643



Büchse IEN 1653



Büchse IEN 3243



Büchse IEN 3253



Büchse VZ 16 oder VZ 16S



Dreiphasen-Überstromschalter 16A/C



Dreiphasen-Überstromschalter 32A/C



Einphasen-Überstromschalter 16A/B

Technische Daten

Nennspannung	400/230 V, (50 Hz)
Nennisolierspannung U_i	500 V
Nennhaltestoßspannung U_{imp}	4 kV
Dauer-Nennstrom $I_u = I_n$	33 A
Schutzart	IP44
Schutzklasse	II
Querschnitt der Anschlussleitungen	2,5...6 mm ²
Ansprech-Charakteristik der Überstromschalter	Typ B (einphasig) Typ C (dreiphasig)

Maße

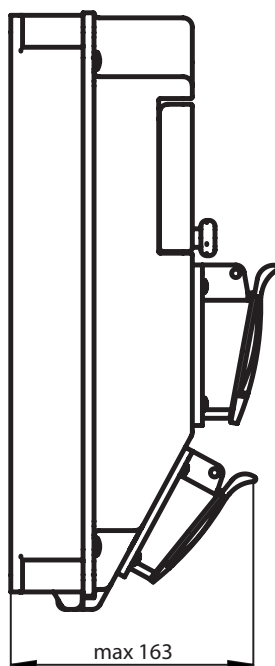
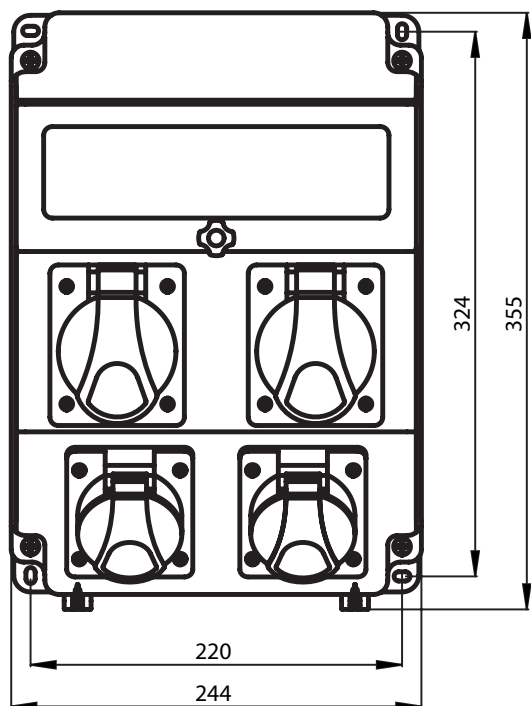

Ausführungen

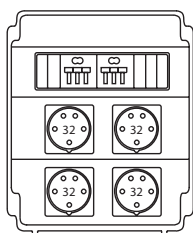

ROS 11V-01

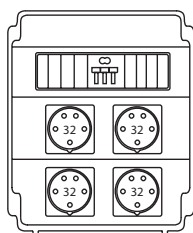

ROS 11V-02

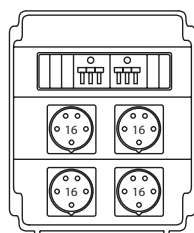

ROS 11V-03

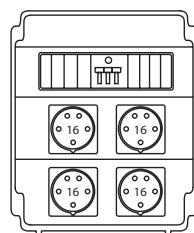

ROS 11V-04

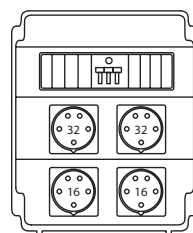

ROS 11V-05

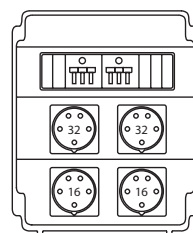

ROS 11V-06

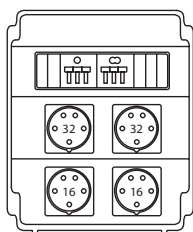

ROS 11V-07

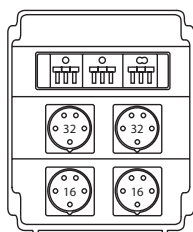

ROS 11V-08

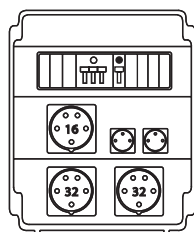

ROS 11V-11

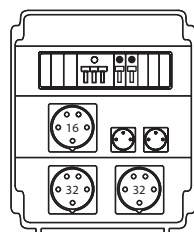

ROS 11V-12

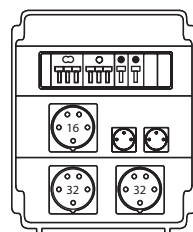

ROS 11V-13

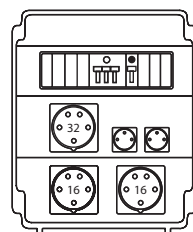

ROS 11V-14

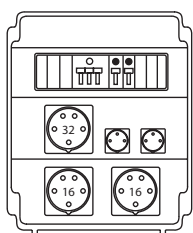

ROS 11V-15

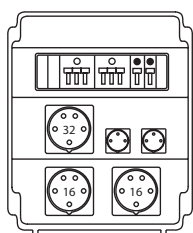

ROS 11V-16

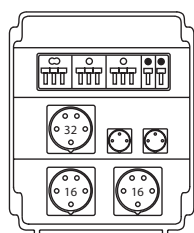

ROS 11V-17

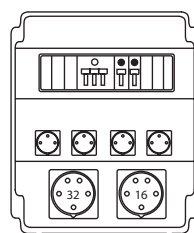

ROS 11V-21

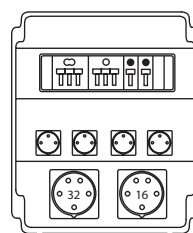

ROS 11V-22

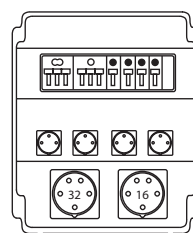

ROS 11V-23

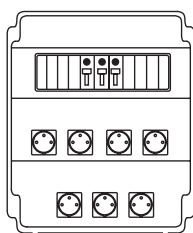

ROS 11V-25

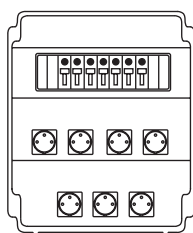

ROS 11V-26

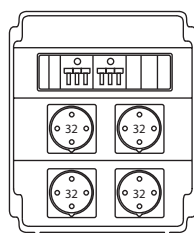

ROS 11V-41

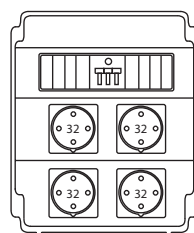

ROS 11V-42

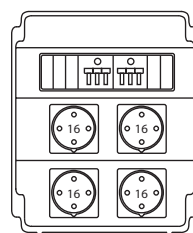

ROS 11V-43

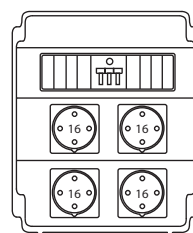

ROS 11V-44

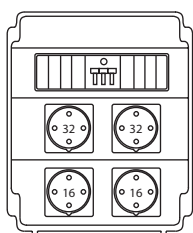

ROS 11V-45

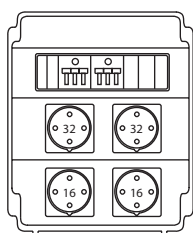

ROS 11V-46

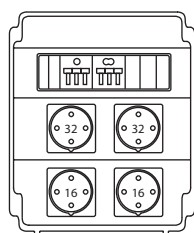

ROS 11V-47

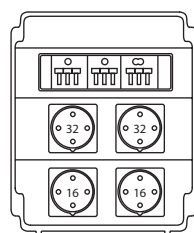

ROS 11V-48

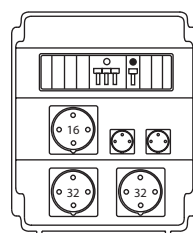

ROS 11V-51

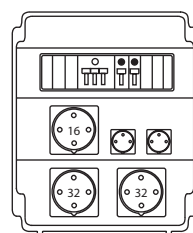

ROS 11V-52

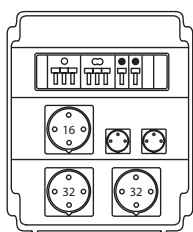

ROS 11V-53

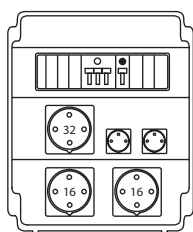

ROS 11V-54

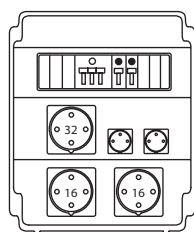

ROS 11V-55

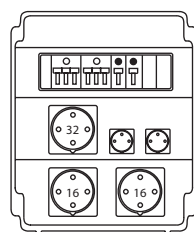

ROS 11V-56

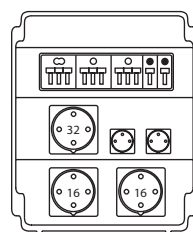

ROS 11V-57

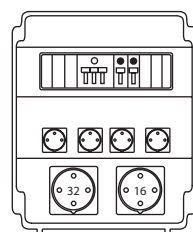

ROS 11V-61

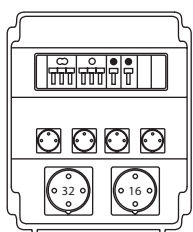

ROS 11V-62

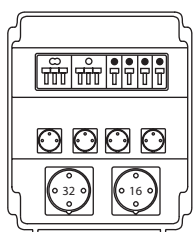

ROS 11V-63