

## Steckdosenverteiler ROS 5\X ohne Absicherungen



### Aufbau der Bestellnummer

ROS 5\X-

Ausführungsnummer des Steckdosenverteilers  
 01, 10, 12, 14, 15  
 41, 50, 52, 54, 55

### Aufbau des Steckdosenverteilers



Büchse IEN 1643



Büchse IEN 1653



Büchse IEN 3243



Büchse IEN 3253



Büchse VZ 16 oder VZ 16S

### Technische Daten

Nennspannung	400/230 V, (50 Hz)
Nennisolierspannung $U_i$	500 V
Nennhaltestoßspannung $U_{imp}$	4 kV
Dauer-Nennstrom $I_u = I_n$	33 A
Schutzart	IP44
Schutzklasse	II
Querschnitt der Anschlussleitungen	2,5...6 mm <sup>2</sup>

### Maße

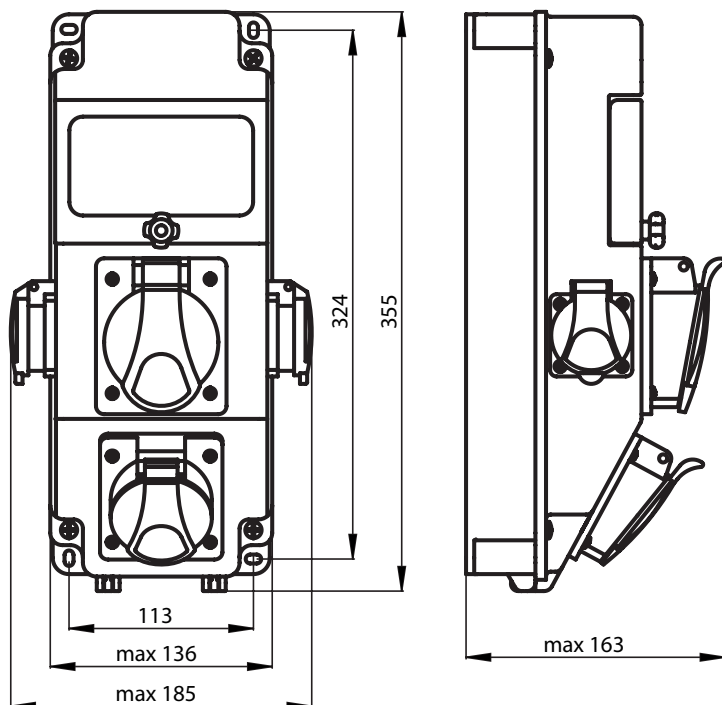

## Ausführungen

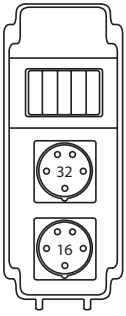

ROS 5\X-01

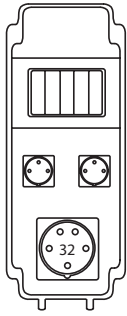

ROS 5\X-10

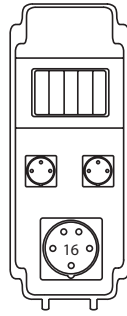

ROS 5\X-12

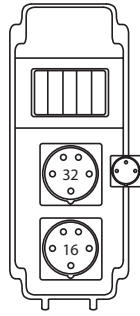

ROS 5\X-14

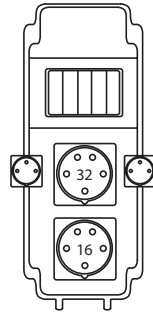

ROS 5\X-15

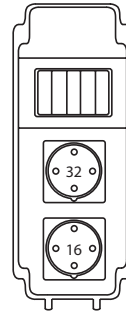

ROS 5\X-41

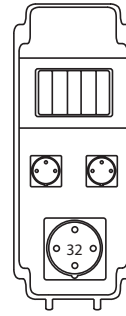

ROS 5\X-50

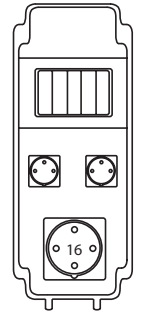

ROS 5\X-52

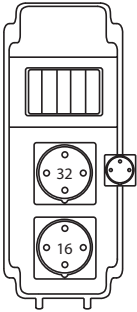

ROS 5\X-54

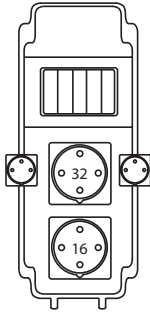

ROS 5\X-55