

Distribution board ROS 5I with protection



Ordering code

ROS 5I-

Assembly number of distribution board

01, 10, 11, 12, 13
14, 15, 16, 41, 50
51, 52, 53, 54, 55
56

Design of the distribution boards



Socket IEN 1643



Socket IEN 1653



Socket IEN 3243



Socket IEN 3253



Socket VZ 16 or VZ 16S



3-phase overcurrent circuit breaker 16A/C



3-phase overcurrent circuit breaker 32A/C



1-phase overcurrent circuit breaker 16A/B

Technical data

Rated voltage	400/230 V, (50 Hz)
Rated insulation voltage U_i	500 V
Rated withstand impulse voltage U_{imp}	4 kV
Rated continuous current I_n	32 A
Protection level	IP44
Protection class	II
Wire gauge	2.5...6 mm ²
Tripping characteristic of miniature circuit breakers	type B (1-phase) type C (3-phase)

Dimensions

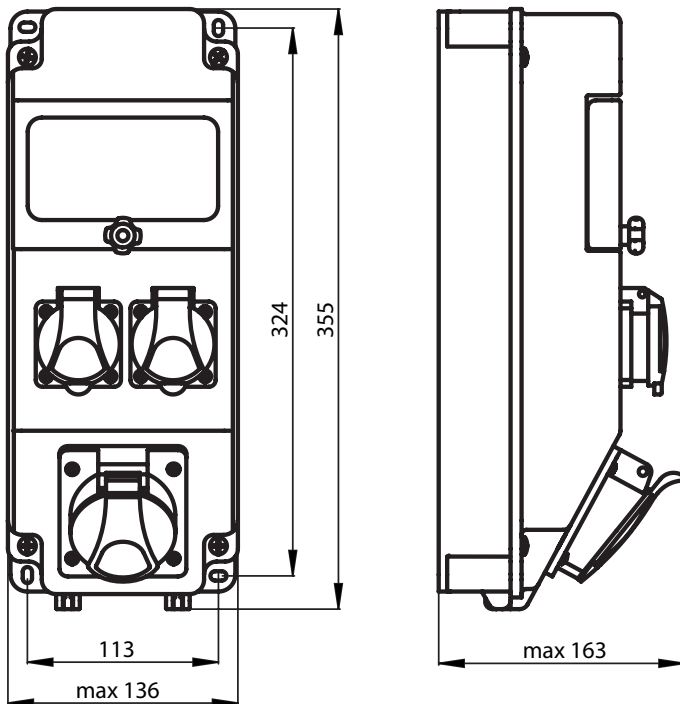

Assemblies

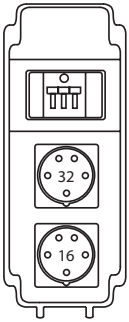

ROS 5\I-01

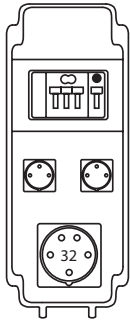

ROS 5\I-10

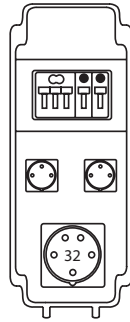

ROS 5\I-11

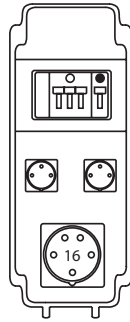

ROS 5\I-12

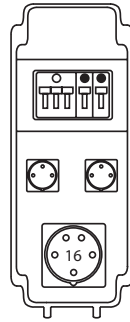

ROS 5\I-13

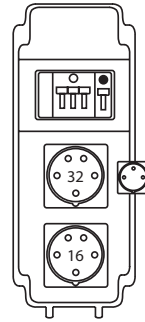

ROS 5\I-14

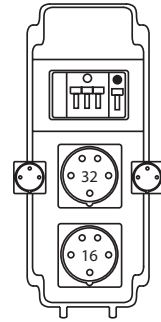

ROS 5\I-15

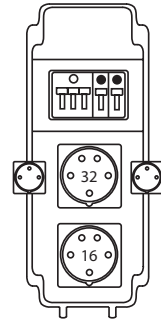

ROS 5\I-16

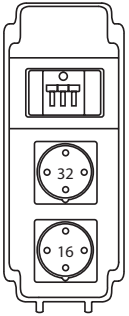

ROS 5\I-41

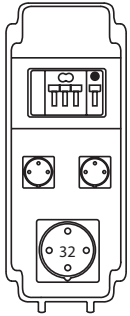

ROS 5\I-50

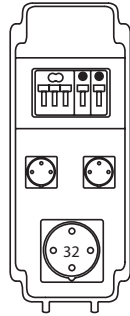

ROS 5\I-51

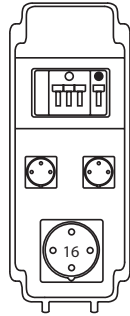

ROS 5\I-52

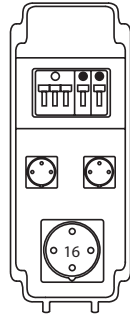

ROS 5\I-53

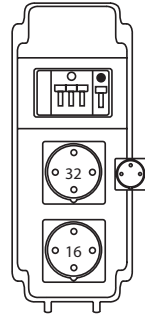

ROS 5\I-54

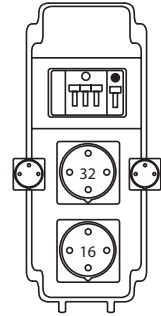

ROS 5\I-55

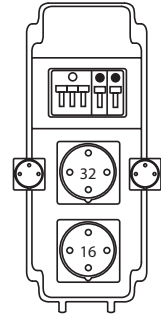

ROS 5\I-56