

Distribution board ROS 5\X without protection







Ordering code

ROS 5\X-

Assembly number of distribution board
01, 10, 12, 14, 15
41, 50, 52, 54, 55

Design of the distribution boards

-  Socket IEN 1643
-  Socket IEN 1653
-  Socket IEN 3243
-  Socket IEN 3253
-  Socket VZ 16 or VZ 16S

Technical data

Rated voltage	400/230 V, (50 Hz)
Rated insulation voltage U_i	500 V
Rated withstand impulse voltage U_{imp}	4 kV
Rated continuous current I_u	32 A
Protection level	IP44
Protection class	II
Wire gauge	2.5...6 mm ²

Dimensions

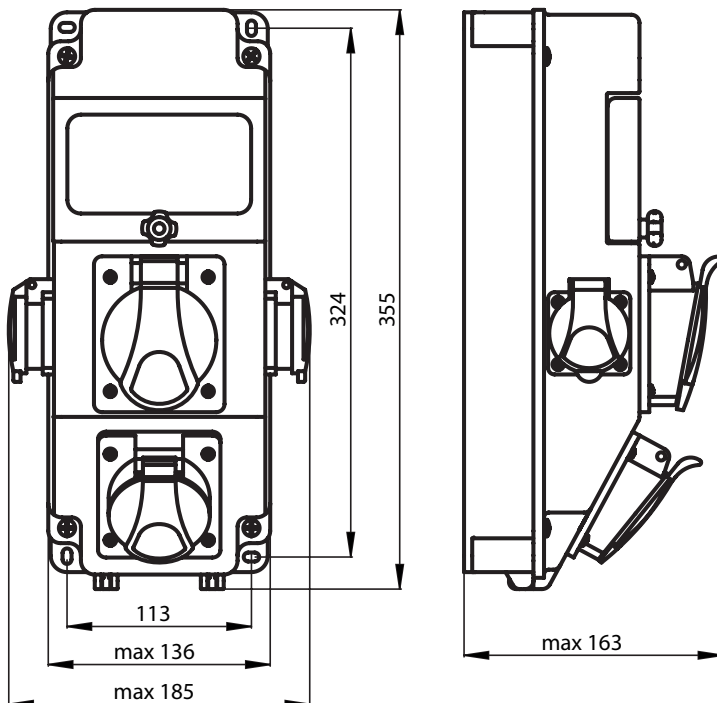

Assemblies

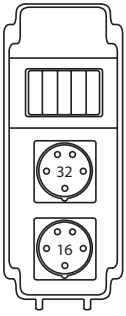

ROS 5\X-01

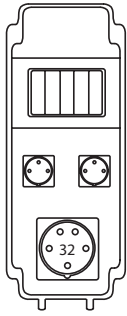

ROS 5\X-10

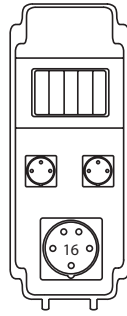

ROS 5\X-12

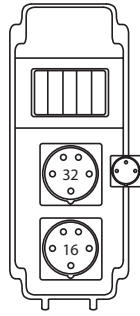

ROS 5\X-14

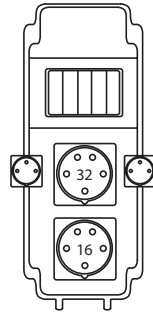

ROS 5\X-15

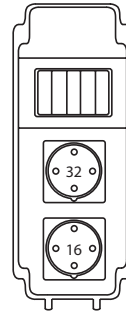

ROS 5\X-41

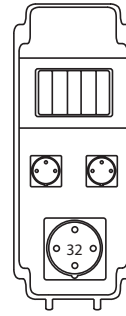

ROS 5\X-50

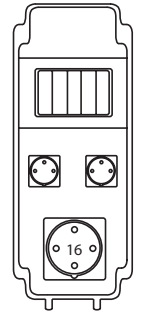

ROS 5\X-52

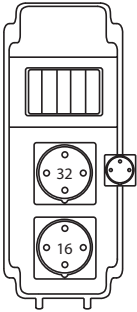

ROS 5\X-54

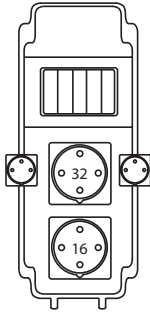

ROS 5\X-55