

Isolating switch disconnecter RSI 63

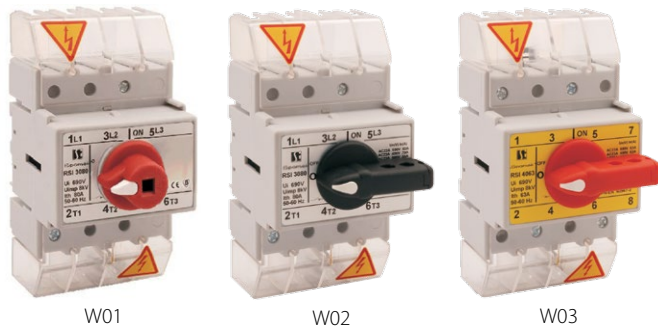

W01

W02

W03

Technical data (continuous work)

Rated insulation voltage U_i	690 V
Rated withstand impulse voltage U_{imp}	8 kV
Conventional rated thermal current in the air I_{th}	63 A
Rated operational current I_e for AC-21A, AC-22A	63 A (690 V)
Rated operational current I_e for AC-23A	63 A (400 V) 45 A (500 V) 30 A (690 V)
Rated power AC-23A for 3-phase standard asynchronous motors	30 kW (400 V) 30 kW (500 V) 25 kW (690 V)
Rated operational current I_e for DC-21A	63 A (220 V)
Rated operational current I_e for DC-22A	40 A (220 V)
Rated operational current I_e for DC-23A	30 A (220V)
Short-time short-circuit withstand current $I_{cw}(1s)$	1.8 kA
Rated short-circuit making current I_{cm}	6 kA
Rated conventional short-circuit current	15 kA (fuse link gL/gG 63 A)
Mechanical endurance	10000 (cycles)
Electrical endurance	1500 (cycles)
Wire gauge	6...16 mm ² (solid)
Weight	0.3...0.32 kg
Vibration test (acc. to IEC 60068-2-6)	2...100 Hz (frequency) ± 1 mm (amplitude) ±0.7 g (acceleration)
Shock test (acc. to IEC 60068-2-27)	15 g (peak acceleration) 11 ms (impulse duration)
Damp heat cyclic test (acc. to IEC 60068-2-30)	55°C (ambient temperature) 95% (relative humidity)
Salt mist cyclic test (acc. to IEC 60068-2-52)	severity 1

Ordering code

RSI- \

Disconnecter knob

- W01** for external knob
- W02** with knob on black disconnecter
- W03** with knob on red disconnecter

Disconnecter poles

- 3063** 3 poles
- 3063N** 3 poles + N non-switched
- 4063** 4 poles
- 4063N** 3 bieguny + N rozłączny
- 6063** 6 poles
- 6063N** 6 poles + 2xN non-switched
- 8063** 8 poles

Disconnecter poles

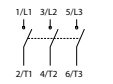

3 poles

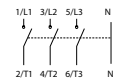

3 poles + N non-switched

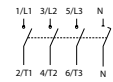

3 poles + N switched

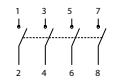

4 poles

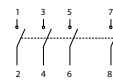

6 poles

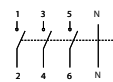

6 poles + 2xN non-switched

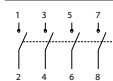

8 poles

Accessories

Auxiliary contact SP80

Knob PR 30

Shaft with a lock RSI 160-1919

Mounted behind the board, RSI 80-1203 for assembly W01

Shaft clamps for RSI, PRZK RSI160-6621\P01

Dimensions

Dimensions of 3 and 4-pole

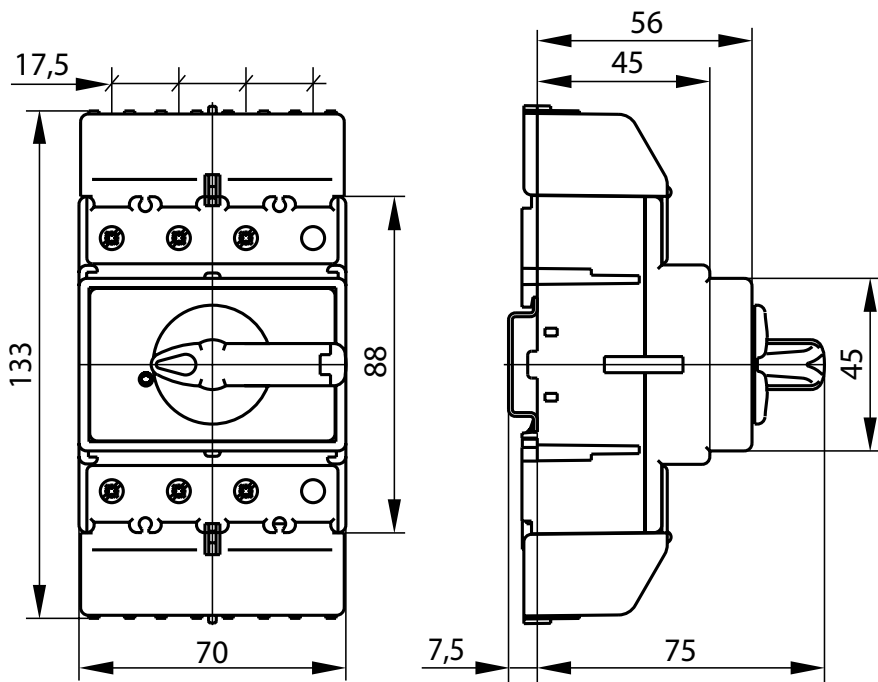

Dimensions of 6 and 8-pole

