

Instalační souprava ZI2 se spínačem 0-I



IP44

IP67

Popis výrobku

Nové Instalační soupravy jsou charakteristické svým novým ergonomickým designem. Každá souprava je vybavena zásuvkou 16 nebo 32 A (podle varianty). Soupravy ZI s vypínačem 0-I **řádek krzywkowy**, vybaveny hlavní zásuvkou a podle typu 1-2 boční (1 fázovou) boční zásuvkou. Instalační soupravy splňují požadavky norem: PN-EN 60439-3, PN-EN 60439-1

Nové Instalační soupravy splňují na Směrnice RoHS 2002/95/WE.

Elektrické schéma

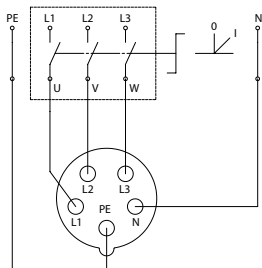

Rozměry

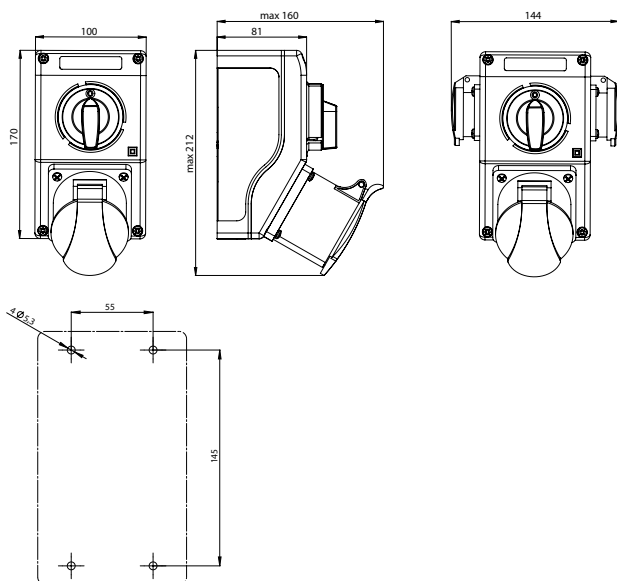

Složení objednáčíchó kódu

ZI

Č. provedení sestavy

22\R111, 26\R111, 22\R211, 26\R211
22\R571, 26\R571, 23\R111, 23\R211
23\R581, 24\R111, 24\R211, 24\R511
22\R341, 26\R341, 22\R441, 26\R441
25\R341-B, 25\R342-B, 25\R441-B, 25\R442-B

Pozor: Boční 1 fázová zásuvka je standardně instalována na pravé straně soupravy. Existuje možnost objednání soupravy s boční zásuvkou na levé straně. Za tímto účelem je nutné dopsat symbol "L" např. **ZI23\R111L**

Stupeň krytí **IP65/IP67** je u verzí: ZI26\R111, ZI26\R211, ZI26\R341, ZI26\R441, ZI26\R441, ZI26\R571.

Technické data

Jmenovité izolační napětí U_i	500 V
Jmenovitý tepelný proud I_{θ}	max 32 A
Jmenovitý kmitočet	50-60 Hz
Jmenovité napětí spínací U_e	230/400 V
Jmenovité impulzní napětí U_{imp}	6 kV
Průřez připojovacích vodičů	2,5...6 mm ²
Stupeň ochrany	IP44; IP65/IP67
Stupeň ochrany	II
Váha	0,8...1,2 kg
Druh vývodek	M25×1,5 (16 A) M32×1,5 (32 A)

Prvky souprav

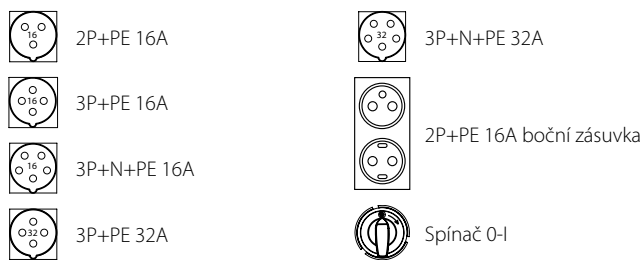

Rozmístění kontaktů zásuvek

2P+PE 16 A, 230V

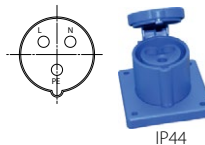

IP44

3P+PE 16 A 400V, 32 A 400V



IP44

IP67

3P+N+PE 16 A 400V, 32 A 400V



IP44

IP67

2P+PE 16 A 230V boční zásuvka

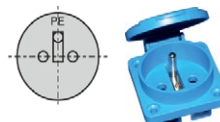

IP44

Provedení

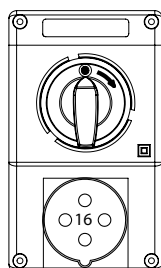

ZI22\R111

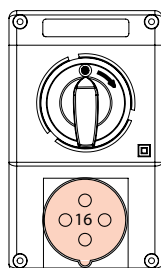

ZI26\R111

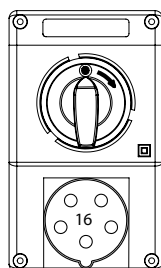

ZI22\R211

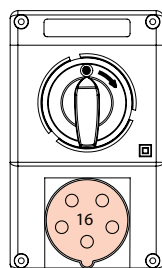

ZI26\R211

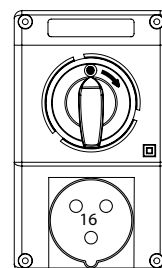

ZI22\R571

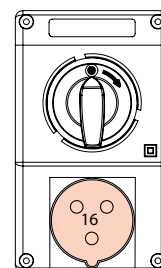

ZI26\R571

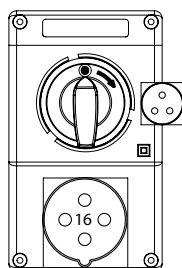

ZI23\R111

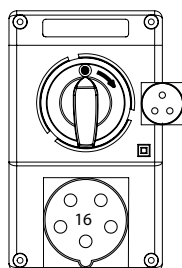

ZI23\R211

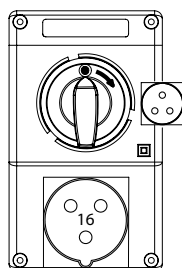

ZI23\R581

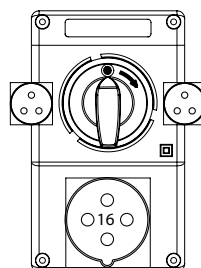

ZI24\R111

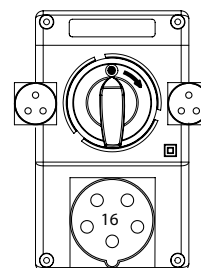

ZI24\R211

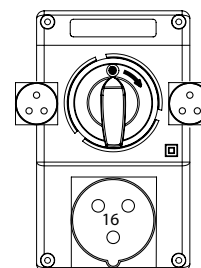

ZI24\R511

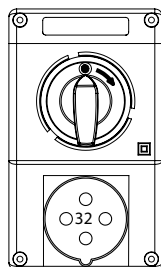

ZI22\R341

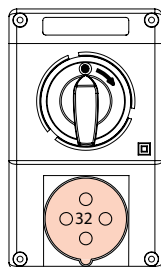

ZI26\R341

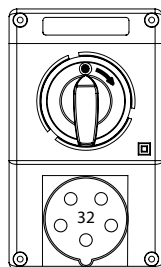

ZI22\R441

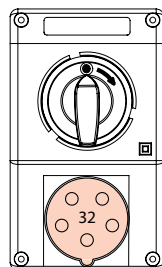

ZI26\R441

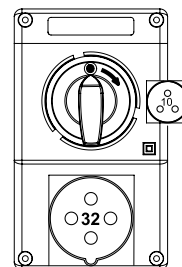

ZI25\R341-B

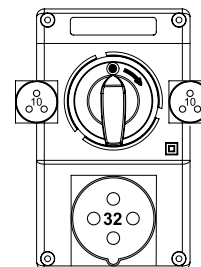

ZI25\R342-B

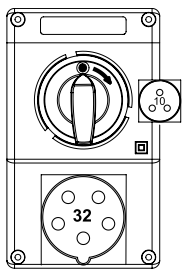

ZI25\R441-B

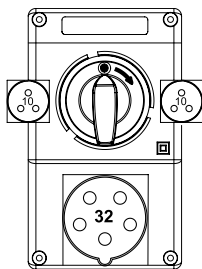

ZI25\R442-B